

⚡ CHARGESPOT

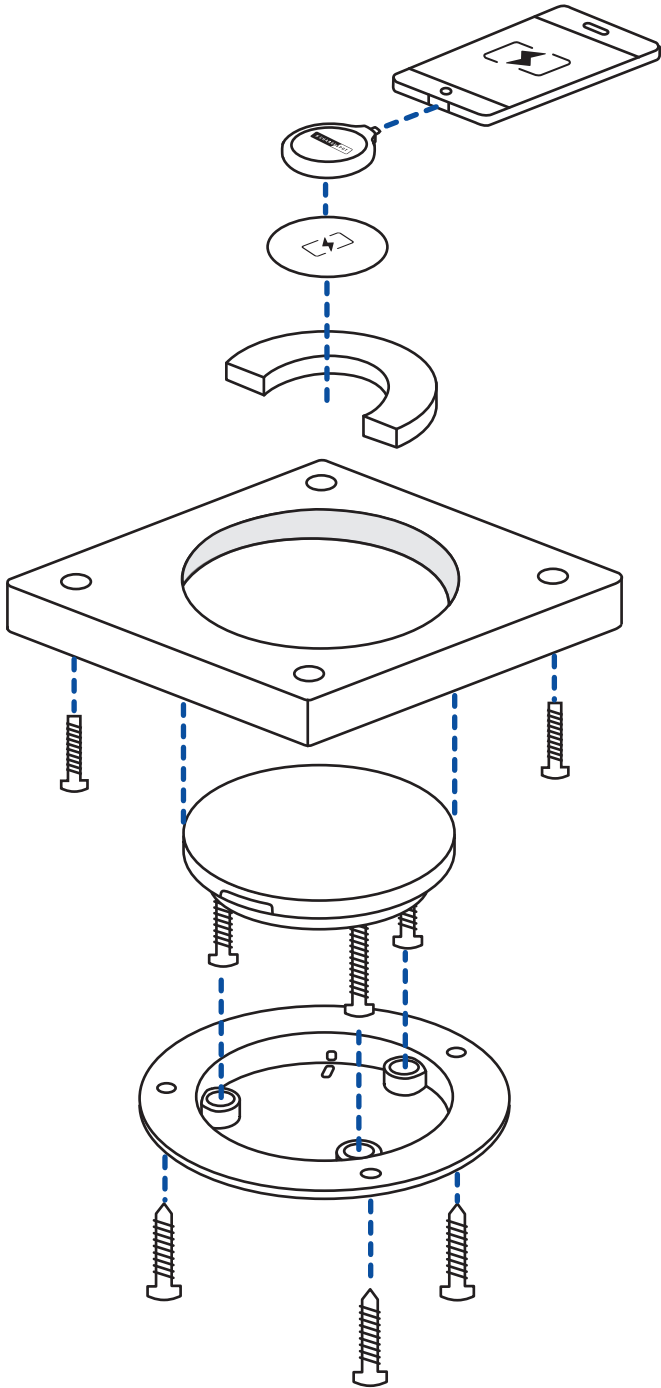

PRODUCT MANUAL

IMPORTANT PURPOSE OF DOCUMENT

THIS DOCUMENT IS FOR USE ONLY BY ORIGINAL EQUIPMENT MANUFACTURERS (OEMS), OEM DEALERS OR INSTALLATION SERVICE FIRMS (TOGETHER INSTALLERS) WHO PURCHASE THE REFERENCED CHARGESPOT COMPONENTS FROM CHARGESPOT WIRELESS POWER INC OR ITS AFFILIATES (CHARGESPOT).

CHARGESPOT ASSUMES THAT ALL INSTALLERS WHO PURCHASE FROM CHARGESPOT AND WHO USE THIS DOCUMENT HAVE EXPERTISE IN THE USE OF ELECTRICAL DEVICES AND COMPONENTS, INCLUDING THE EXPERTISE NECESSARY TO (i) DETERMINE WHETHER OR NOT CHARGESPOT COMPONENTS ARE SUITABLE FOR USE IN THE SURFACE SUCH COMPONENTS WILL BE INSTALLED IN, AND (ii) PROPERLY AND SAFELY CONFIGURE AND INSTALL CHARGESPOT COMPONENTS. ACCORDINGLY, THIS DOCUMENT IS INTENDED ONLY AS A HELPFUL SUPPLEMENT FOR USE BY THE INSTALLER AND NOT AS A SUBSTITUTE FOR THE INSTALLER'S EXPERTISE. IF ANY INSTALLER USING THIS DOCUMENT LACKS SUCH EXPERTISE OR DOES NOT AGREE TO THE FOREGOING LIMITED PURPOSE STATED FOR THIS DOCUMENT, SUCH INSTALLER SHOULD IMMEDIATELY NOTIFY CHARGESPOT IN WRITING TO THAT EFFECT AND SHOULD NOT USE THIS DOCUMENT. PRICES AND OTHER TERMS AND CONDITIONS FOR SALE OF CHARGESPOT COMPONENTS TO ANY INSTALLER ARE GOVERNED BY SEPARATE DOCUMENTS ISSUED OR MADE AVAILABLE TO THE INSTALLER BY CHARGESPOT, INCLUDING THE INVOICE ISSUED BY CHARGESPOT AND THE STANDARD TERMS AND CONDITIONS OF SALE LOCATED AT www.chargespot.com/termsandconditions.html.

SAFETY INFORMATION

CHARGESPOT EXPECTS THAT THE OEM WILL INCLUDE APPROPRIATE SAFETY WARNINGS AND INFORMATION FOR END USERS OF ALL OEM PRODUCTS, WHICH INCORPORATE CHARGESPOT COMPONENTS. SUCH WARNINGS AND INFORMATION MUST INCLUDE THOSE SET FORTH BELOW AND OTHER WARNINGS AND INFORMATION AS THE OEM DETERMINES NECESSARY AND APPROPRIATE.

DANGER

To reduce the risk of electrical shock:

- Always unplug the ChargeSpot from the electrical outlet before removing
- Do not reach for a ChargeSpot that has fallen into water – unplug it immediately
- Do not disassemble or modify any part of the ChargeSpot
- Do not install this product in any electrically conductive surface

WARNING

To reduce the risk of burns, fire, electrical shock, or injury to persons:

- This product should not be used by children or persons with disabilities that may hinder their ability to understand all product information and use the product safely. Close supervision is necessary when this product is used near children or persons with disabilities
- Use this product only for its intended use as described in this manual
- Never operate this product if it has a damaged housing, cord or plug cable
- Keep cord away from heated surfaces and liquids
- Do not operate where aerosol products are being used or oxygen is being administered
- This product is designed for indoor use only. Do not install or use this product outdoors
- Do not use the ChargeSpot with an extension cord or overloaded electrical outlet
- Do not place or leave metallic objects between the charging surface and device being charged
- It is recommended that the ChargeSpot be installed to provide 10 cm of separation from persons

IMPORTANT SAFETY INSTRUCTIONS

- **SAVE THESE INSTRUCTIONS** – This manual contains important safety and operating instructions for ChargeSpot
- Before using the inductive charger, read all instructions and cautionary markings on the inductive charger, power supply, and product using the inductive charger
- **CAUTION** – To reduce risk of injury, charge only Qi-certified or PMA-certified products. Other types of inductive charging devices may cause personal injury and damage
- Install the device minimum 20 centimeters away from the user's body.

FCC & INDUSTRY CANADA COMPLIANCE

NOTICE: Changes or Modifications made to this device not expressly approved by ChargeSpot Wireless Power Inc. may void the U.S. FCC and Canadian authorization to operate this device.

This device complies with part 15 of the FCC Rules. Operation is subject to the following two conditions:

- (1) This device may not cause harmful interference, and
- (2) this device must accept any interference received, including interference that may cause undesired operation.

NOTE: This equipment has been tested and found to comply with the limits for a Class B digital device, pursuant to part 15 of the FCC Rules. These limits are designed to provide reasonable protection against harmful interference in a residential installation. This equipment generates, uses and can radiate radio frequency energy and, if not installed and used in accordance with the instructions, may cause harmful interference to radio communications. However, there is no guarantee that interference will not occur in a particular installation. If this equipment does cause harmful interference to radio or television reception, which can be determined by turning the equipment off and on, the user is encouraged to try to correct the interference by one or more of the following measures:

- Reorient or relocate the receiving antenna.
- Increase the separation between the equipment and receiver.
- Connect the equipment into an outlet on a circuit different from that to which the receiver is connected.
- Consult the dealer or an experienced radio/TV technician for help.

This device complies with Industry Canada's licence-exempt RSSs. Operation is subject to the following two conditions:

- (1) This device may not cause interference; and
- (2) This device must accept any interference, including interference that may cause undesired operation of the device.

This equipment complies with Industry Canada RF exposure limits set forth for an uncontrolled environment. The device and its antenna must not be co-located or operating in conjunction with any other antenna or transmitter. This equipment complies with FCC RF exposure limits set forth for an uncontrolled environment. The device and its antenna must not be co-located or operating in conjunction with any other antenna or transmitter. The equipment should be installed and operated with minimum distance 20 cm between the the transmitter and your body.

SAFETY CONSIDERATION FOR INSTALLERS

Safety is dependent on the proper installation and servicing of the ChargeSpot. It is important to read and follow all instructions before installing this product. To properly install a ChargeSpot you must have a good understanding of electrical procedures and systems, along with proficiency in the installation and service of office, commercial and residential work surfaces. There are no adjustments required at any time to the electrical components within the charging mount. OEMs and installers should not open the ChargeSpot housings or make modifications to the ChargeSpot or components unless expressly approved in writing by an authorized representative of ChargeSpot Wireless Power Inc. Any changes or modifications will void the product warranty.

DURING INSTALLATION

- **DO NOT** connect the ChargeSpot to an electrical outlet until:
 - **ALL** other electrical connections are made
 - Mounting of **ALL** components is complete
 - **VERIFICATION** that no short circuit exists in the entire system
- **DO NOT** install equipment or route wiring cords in the path of any walkways or moving components
- When drilling into the work surface, **DO** make sure that both sides of the surface are clear of anything that could be damaged

AFTER INSTALLATION

- Test the installed ChargeSpot to ensure that it is working properly
- File these instructions in a safe place and refer to them when performing maintenance or re-installing

WARNING: Failure to follow all safety precautions and instructions may result in death, serious injury, or property damage. The OEM assumes sole responsibility for such precautions and instructions and for any failure to follow them.

DISCLAIMER

By proceeding with the installation of ChargeSpot components in OEM products, the OEM agrees that: (i) CHARGESPOT is not liable under any theory of contract, tort law, or otherwise for any loss, damage, death, personal injury, special, incidental, or consequential damages, or any other damage of any nature arising directly or indirectly from or relating to the improper installation or use of CHARGESPOT products or components in residential or office furniture or any other application; and (ii) the OEM will defend, indemnify, protect, and hold harmless CHARGESPOT and each of its affiliates, officers, directors, agents, and employees from and against any such liability,

claims, injuries, losses, and damages. In order to safely install and use CHARGESPOT products and components, full consideration of the work environment (e.g., location of electrical wiring, support members, surface thicknesses, and other electrical and structural components) is required. CHARGESPOT disclaims responsibility for improper use or installation of products or components and use or installation not consistent with the original manufacturer specifications and recommendations (if any) for such products or components.

WARRANTY INFORMATION

Neither this document nor the statements in this document create any warranties, express or implied, regarding ChargeSpot components. All information regarding any warranties made by CHARGESPOT to the OEM purchaser of ChargeSpot components is located in separate documentation provided by CHARGESPOT to the OEM. CHARGESPOT makes no other warranties and specifically disclaims any express or implied warranties of merchantability or fitness for purpose. No warranty shall extend to any person other than the OEM who purchases the ChargeSpot component from CHARGESPOT.

PRE-INSTALLATION CONSIDERATION

The OEM is solely responsible for taking all steps necessary and appropriate for safe and proper installation of ChargeSpot components. These steps include, without limitation, the following:

INSTRUCTIONS & PERSONNEL

The OEM should use only properly trained and qualified personnel for installation. The OEM should assure that all such personnel read and fully understand this document prior to beginning installation.

CONDUCT A “BENCH TEST”

The OEM should conduct a “bench test” to verify that all electronic issues are resolved prior to installation:

- Make sure the ChargeSpot is operational with a Qi-certified or PMA-certified receiver device before being installed
- Check the Power Supply connection for proper fit

CHARGESPOT INSTALLATION KIT

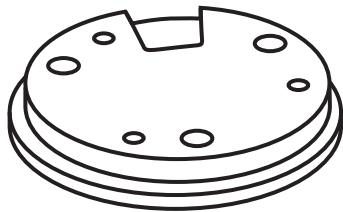

1x ChargeSpot

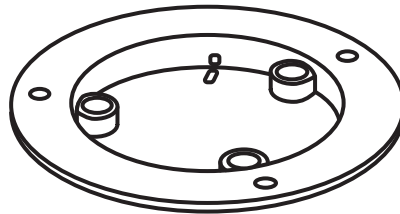

1x Mounting Plate

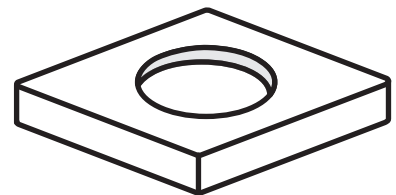

1x ChargeSpot Jig

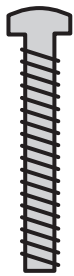

3x
3/4" - #8-32
Machine Screws

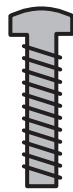

3x
1/2" - #8-32
Machine Screws



3x
1/2" - #6
Wood Screws



3x
Wire Clips

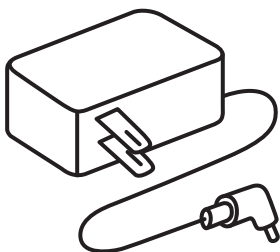

Power Adaptor

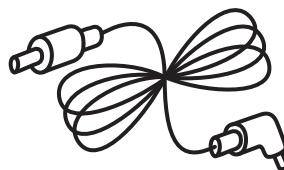

5ft Single-Unit
Power Supply

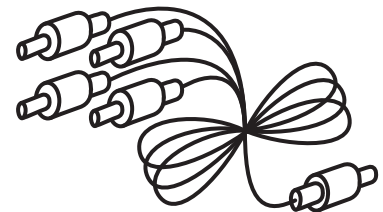

15ft Multi-Unit
Power Supply

----- or -----

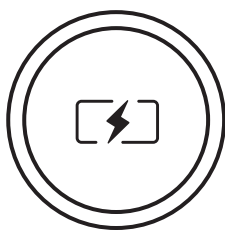

2x Stickers/De-
cals

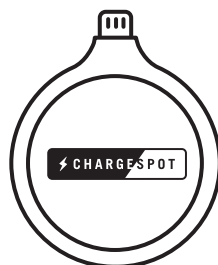

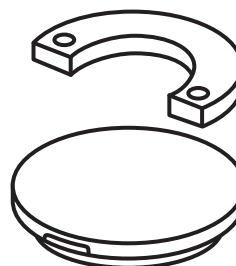

Sparks
Apple Lightning
& mUSB

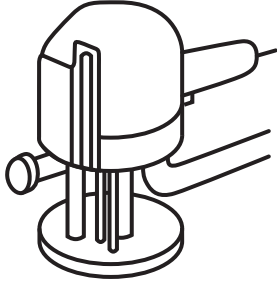
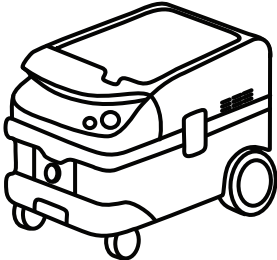

Decal
Placement Tool
(2 pieces)

TOOLING LIST

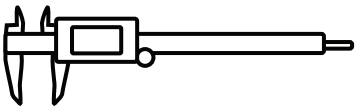
TOOL	NAME	DESCRIPTION
	Festool 574342 OF 1400 EQ Plunge Router	Includes: Chip Catcher, Collets (1/4", 1/2", & 8mm), Dust Extraction Hood, Guide Rods (pair), Plug-It Power Cord, and Standard US Guide Bushing Adapter. Ships in: Systainer 4 Case. Also provided: Printed Supplemental Manual.
	Festool 583492 CT 26 HEPA Dust Extractor	Includes: 27mm Anti-static Hose, Cord Wrap, Filter Bag, HEPA Filter, and Hose Garage.
	Festool 492183 Template Guide, 24mm OD / 21mm ID	Copy ring for use with OF 1400 Router.
	Whiteside 1086 Router Bit Straight 3/4"X1-1/2"	Diameter: 3/4". Cutting Length: 1-1/2". Overall Length: 3". Shank: 1/2". Two-Flute.
	Wixey WR100 Digital Fractional Caliper	Includes: Battery, Case. Measuring Length: 6". Increments: 1/64".
Router jig	Provided by ChargeSpot	
ChargeSpot Decal Placement Tool	Provided by ChargeSpot	
ChargeSpot Test Receiver	Provided by ChargeSpot	

For tooling overviews and set-up please see <https://chargespot.wistia.com/projects/sg6zfb9w1v>

MACHINE SCREW LENGTH

- Substrate thickness affects the device ONLY in screw length.
- Refer to Table 1 for the resulting screw length requirements and proper mounting position (Figure A).

SUBSTRATE THICKNESS	MACHINE SCREW LENGTH
18 - 24mm (0.71" - 0.95")	8-32 x ½" (3 provided)
24 - 31mm (0.95" - 1.2")	8-32 x ¾" (3 provided)
31 - 37mm (1.2" - 1.45")	8-32 x 1" (not included)
37 - 44mm (1.45" - 1.7")	8-32 x 1¼" (not included)
44 - 51mm (1.7" - 2")	8-32 x 1 ½" (not included)

Table 1: Screw Length Selection Based on Substrate Thickness

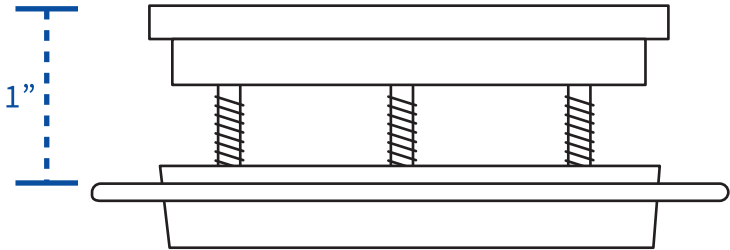

Figure A. ChargeSpot placed in mounting plate

INSTALLATION INSTRUCTIONS

⚠ SAFETY

Please read all safety instructions before installation.

DURING INSTALLATION

DO NOT connect the ChargeSpot to an electrical outlet until:

- ALL other electrical connections are made
- Mounting of ALL components is complete
- VERIFICATION that no short circuit exists in the entire system

DO NOT install equipment or route wiring cords in the path of any walkways or moving components.

When drilling into the work surface, DO make sure that both sides of the surface are clear of anything that could be damaged.

AFTER INSTALLATION

Test the installed ChargeSpot to ensure that it is working properly.

File these instructions in a safe place and refer to them when performing maintenance or re-installing.

PREPARE

ChargeSpot will ship Product Kit with all necessary materials.

Please refer to

<https://chargespot.wistia.com/projects/sg6zfb9w1v> for video tutorials and tool set up.

1 LOCATE

Mark the center for each ChargeSpot location on the underside of the surface (Figure 1).

- Find approximate location on the topside of the surface to ensure correct position.
- (For retrofit only) Ensure adequate working space available for router before cutting (e.g., cutting the holes requires additional space for the router to move).

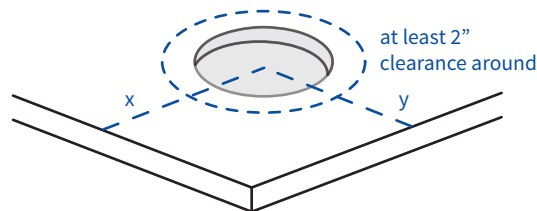

Figure 1a. underside of table

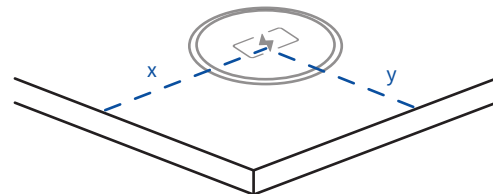

Figure 1b. topside of table

2 MEASURE

Using the digital caliper, measure the thickness of the table and jig together (Figure 2a).

Desired depth of the hole to be cut is 6mm from the surface. **IMPORTANT:** Check for correct measurements before cutting (Figure 2b).

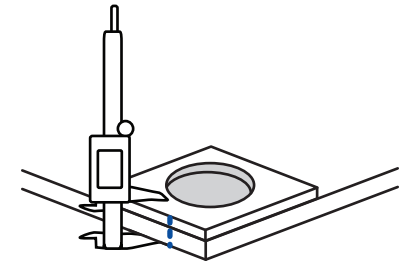

Figure 2a. Measure the table and jig thickness together.

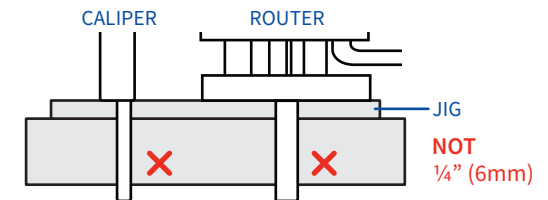
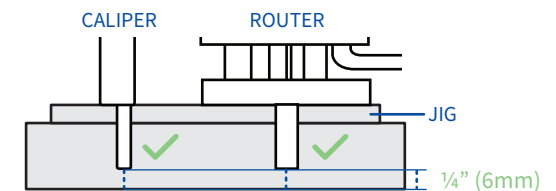

Figure 2b. Use the end of the caliper and the router bit to ensure proper measurement before cutting.

3 CUT

Attach the jig to the desired location with provided screws. A recessed hole that is 3½” in diameter will need to be routed from the underside of the substrate to within 6.0mm from the surface (1/4”) from the surface (Figure 3a, 3b).

- **IMPORTANT:** The depth of the hole must be precise in order for optimal performance of the ChargeSpot (Figure 2b).
- Remove table surface if possible
- Ensure ChargeSpot unit fits into each hole and sits flush in the recessed hole
- Test ChargeSpot unit to ensure remaining surface thickness is to specification
- Take caution not to penetrate the surface when boring the recessed pocket
- The type of substrate the ChargeSpot is mounted into **DOES NOT** affect the installation of the device.

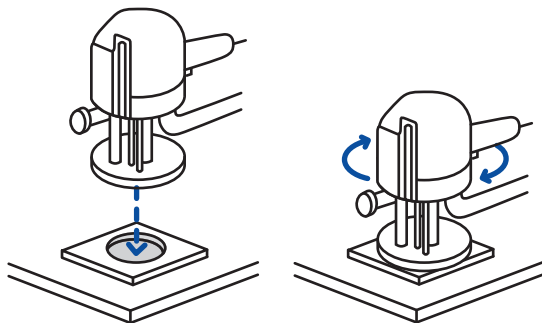

Figure 3a. Move the router clockwise while routing

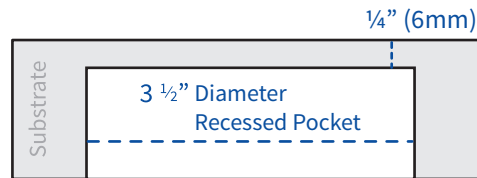

Figure 3b. The recessed hole must be 6mm from the surface

4 DECAL PLACEMENT

After cutting the pocket from the underside use the ChargeSpot decal placement tool (Figure 4) to accurately locate and place the table decal on the topside before mounting.

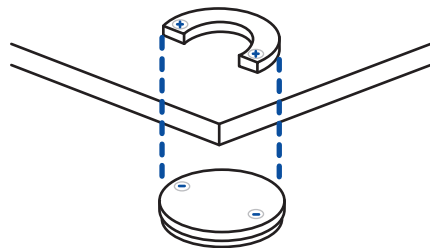

Figure 4a. Decal placement tool (two pieces) are magnetized

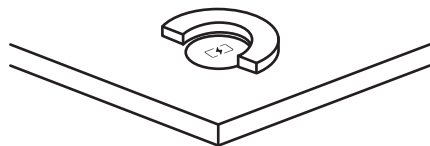

Figure 4b. Use the tool as a guide to place the decal

5 POWER SUPPLY

First connect the power supply to the ChargeSpot before mounting (Figure 5). Plug the power supply into an outlet to test the unit.

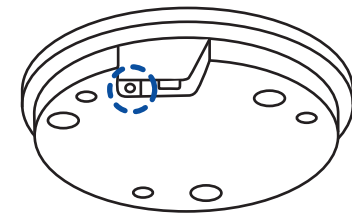

Figure 5. Power supply jack on the ChargeSpot

6 MOUNTING

Determine appropriate machine screw length using attached chart (Page 10).

Attach the three (3) appropriate machine screws to the bottom of the ChargeSpot as demonstrated in Figure 6a below. Ensure that the screws are not tightly fastened to leave room for depth adjustment.

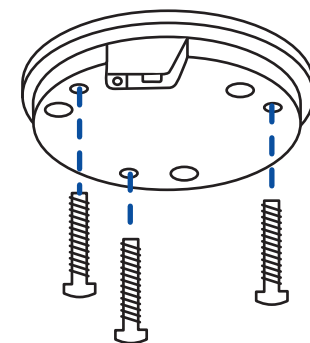

Figure 6a

6 MOUNTING (continued)

- With the three (3) machine screws attached, place the ChargeSpot on top of the mounting plate. Ensure the screws attached to the charger are aligned with the corresponding counter bores on the mounting plate (Figure 6b). The resulting assembly should appear as in Figure 6c.

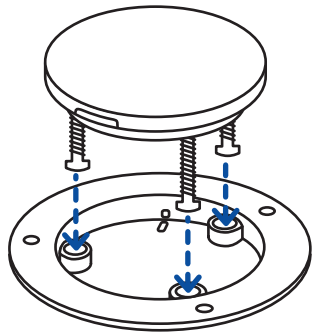

Figure 6b. The screw heads of the ChargeSpot should be placed in the holes of the mounting plate.

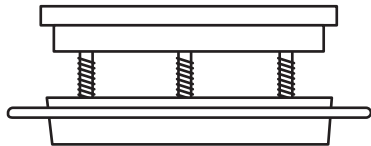

Figure 6c. ChargeSpot with mounting plate

- From the underside of the substrate, place the ChargeSpot with the attached mounting plate into the recessed hole (Figure 6d).

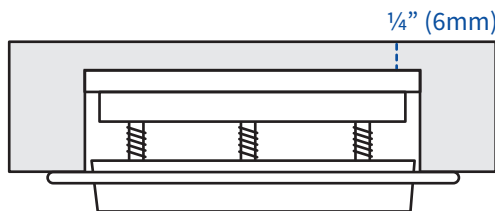

Figure 6d. ChargeSpot placement in recessed hole

- The ChargeSpot requires three (3) no.6 x 1/2" Phillips round-head wood screws to be installed into the mounting plate to hold the charger in place (see dashed circles in Figure 6e). The OEM should ensure that the no.6 x 1/2" Phillips screws do not penetrate the substrate surface. This completes the steps necessary to mount the ChargeSpot.

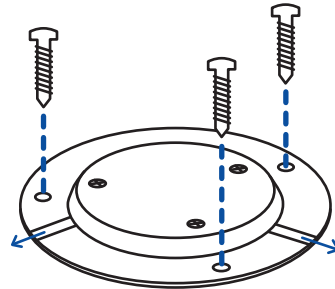

Figure 6e. Secure mounting plate against surface underside

- If the ChargeSpot transmitter is not flush against the under of the substrate, use a Philips head screwdriver to loosen the corresponding machine screws until flush. Note that the transmitter must sit flush against the underside of the substrate to operate properly.
- Consideration and implementation of cord management should be used when installing the power supply.
 - Zip ties can be applied at three (3) points on the mounting plate to tether excess cable to the device (arrows in Figure 6e).
 - Provided wire clips should be used to properly mount wires.
- The ChargeSpot should be positioned on the work surface where the provided power supply can reach an electrical outlet without interfering with walkways or moving components. The ChargeSpot should not be installed in any electrically conductive work surface.

7 TESTING

Confirm that ChargeSpot unit can transfer power to the Test Receiver through the surface

IMPORTANT: The recessed hole must be within 6mm or 1/4" of the surface and the decals must be accurately placed otherwise the Test Receiver LED will fail to light consistently

- Place the Test Receiver over the decal on the surface



Figure 7. Place the Spark on the decal

- The Test Receiver test unit LED should light up within 1 second
- Remove the Test Receiver for 3 seconds. Repeat previous 2 steps two more times to ensure consistency
- TIP: During testing, always reset positioning by picking up and placing the Test Receiver down; 'nudging' will not reset the Test Receiver properly



**CONGRATULATIONS ON
INSTALLING CHARGESPOT.
START CHARGING!**