



PROVIDE POWER WITHOUT WIRES

MEETING ROOMS | WORKSTATIONS |
COMMON SPACES | BOARDROOMS

ChargeSpot is the most aesthetic way to add power to corporate offices. ChargeSpot installs underneath a table and creates a wireless charging zone on top for smartphones. This seamless solution maintains the beauty of your design by avoiding unsightly wires, USB grommets or outlets.

ChargeSpot is simple to use, works with all phones and installs in almost any surface.

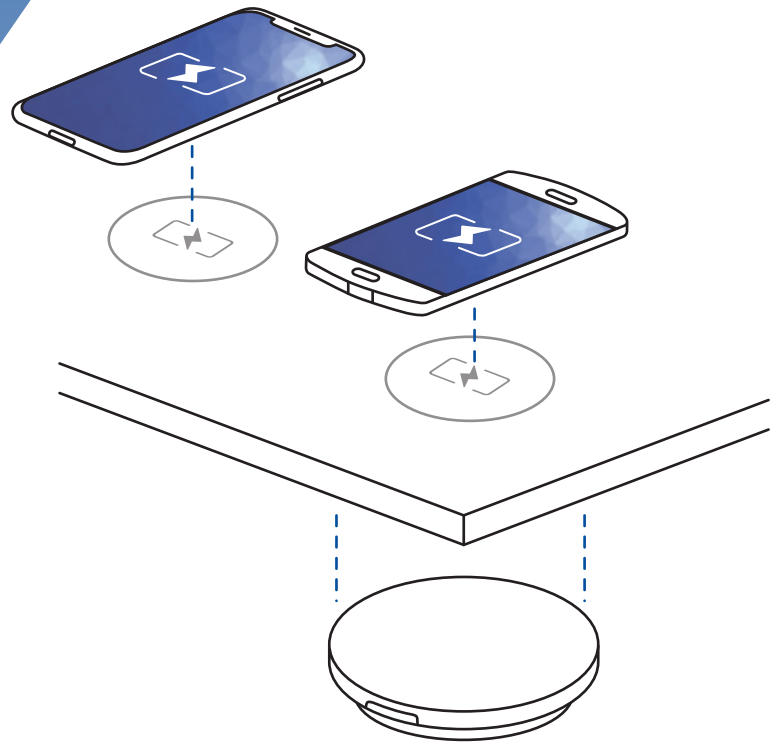

CREATE FUNCTIONAL SPACE

Installs underneath a table and eliminates cords supporting a more mobile and flexible workspace.



DESIGN FRIENDLY ALTERNATIVE TO USB

ChargeSpot replaces unsightly USB ports with a seamless solution that doesn't impact the design or aesthetic of your space.



ELEGANT POWER FOR CLIENTS

Provide a highly demanded amenity in client facing spaces that also demonstrates innovative design.

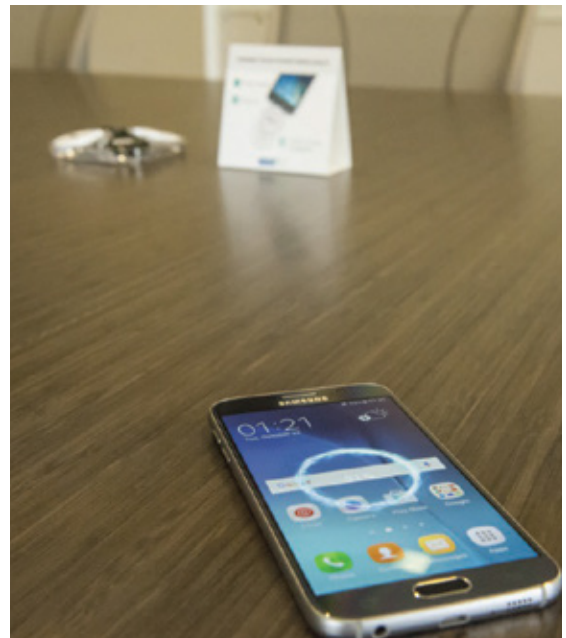

CHARGESPOT

PRODUCT SHEET

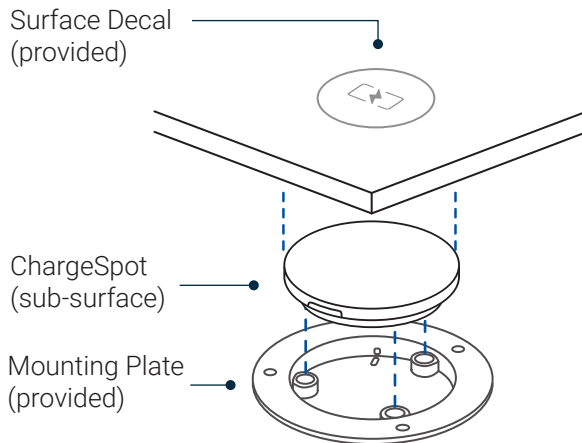

Chargespot is a wireless charging transmitter that installs under table surfaces. It allows anyone to charge their smartphone or tablet. It also is capable of fast charging for devices that can accept higher power transfer.

ChargeSpot is easy to use and install and can be added to any piece of furniture.

A decal denotes the location of the ChargeSpot and marks the spot that users place a device over to begin charging.

Power Output	15 Watts
Product Dimensions	3½" (89mm) Diameter x ¾" (19mm) Height
Power Supply	19V 1350mA (Sold Separately)
Wireless Power Protocols	WPC 1.2
Non-Compatible Surfaces	Metal, Glass

Last Updated: July 19, 2017

POWER SUPPLY OPTIONS

SINGLE UNIT POWER SUPPLY

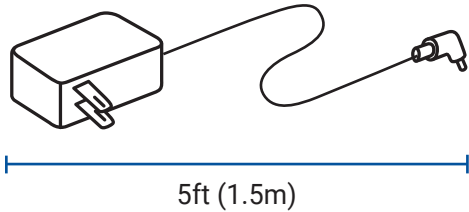

The Single-Unit Power Supply is capable of providing power to one (1) ChargeSpot. Great for individual work stations and in other layouts to supplement Multi-Unit Power Supplies.

Power Output	19 Volt, 1.35 Amp
Product Dimensions	Adapter: 3 ¼" (82.5mm) Length, 1 ⅝" (41mm) Height, 2" (50mm) Width, Full Length (with Cord): 5 ft.
# of ChargeSpots Powered	1

MULTI UNIT POWER SUPPLY (4 units)

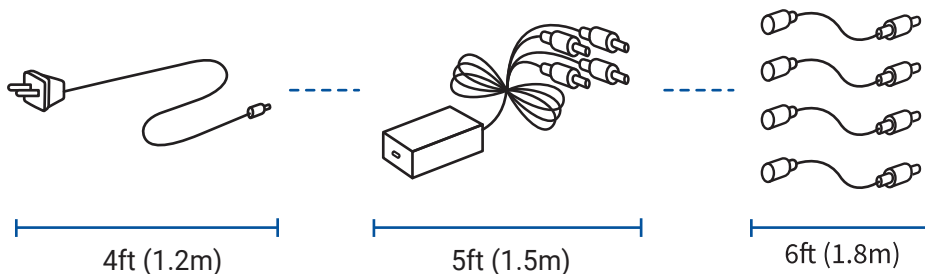

The Multi Unit Power Supply is capable of providing power to four (4) ChargeSpots. Great for conference tables and meeting rooms.

Power Output	19 Volt, 5 Amp
Product Dimensions	Box: 5 ⅜" (136mm), Length, 2 ¼" (59mm) Width, 1 ⅜" (35mm) Height, Full Length (connected): 15 ft.
# of ChargeSpots Powered	4

Last Updated: July 19, 2017

SPARK

PRODUCT SHEET



Apple Lightning
(Apple Products)



microUSB
(Android Products)

The Spark is a wireless charging receiver that allows any phone or tablet to use ChargeSpot. Simply place the plugged in Spark over a ChargeSpot to begin charging.

Many new smartphones do not require the Spark. They have a wireless charging receiver already built in (For example, the Samsung Galaxy S8/8+ and iPhone 8 / 8 Plus / X).

Product Dimensions	52.5mm (2") length, 39.5mm width (1.5"), 8mm (0.3") height
Connectors	Apple Lightning or microUSB
Wireless Power Protocols	WPC Qi 1.2 Medium Power

SALES KIT

PRODUCT SHEET

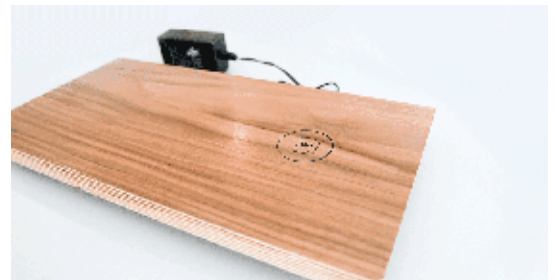
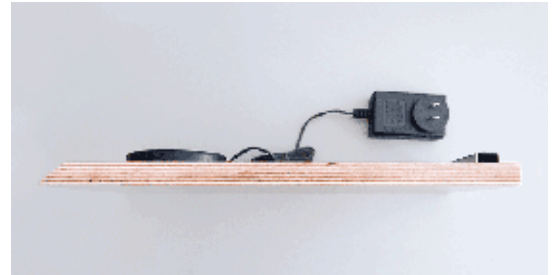

The ChargeSpot Sales Kit makes it easy to demo ChargeSpot anywhere.

Chargespot is a wireless charging transmitter that installs under table surfaces. It allows anyone to charge their smartphone or tablet. It also is capable of fast charging for devices that can accept higher power transfer.

A decal denotes the location of the ChargeSpot and marks the spot that users place a device over to begin charging.

Power Output	ChargeSpot: 15 Watts. Power Supply: 19 Volt, 1.35 Amp. Sparks: DC 5V, 500mA
Product Dimensions	14½" (36.8cm) Length, 7¼" Width (18.4cm), 1¼" (31.8mm) Height Sparks: 11/2"(58mm) Length x 7/8" (7.5mm) Depth Cord: 5ft
Connectors	microUSB and Apple Lightning
Power Supply	19V 1350mA
Wireless Power Protocols	WPC 1.2

Last Updated: July 19, 2017